

Check Valves, Flow Control and Priority Flow Control Valves



Applications

Sun check valves provide non-modulating on/off control, and Sun flow control valves provide flow modulation for control of metering and flow regulation in a variety of forms:

- Two port cartridges for check and flow control valves.
- Three port cartridges for priority flow control valves.
- Four port cartridges for priority flow control valves.

Sun two port check and flow control cartridges can be applied as:

- Basic check valves (two flow paths available).
- Fixed orifice restrictor valves with reverse flow check.
- Fully adjustable needle valves with or without reverse flow check.
- Pressure compensated, fixed orifice, flow controls with or without reverse flow check.
- Pressure compensated, fully adjustable flow controls with reverse flow check.

Sun three and four port flow regulating cartridges can be applied as:

- Pressure compensated, bypass and restrictive, fixed orifice priority flow control.
- Ventable (remote controllable), pressure compensated, bypass and restrictive, fixed orifice priority flow control.

Sun check valves have nominal flow capacities up to 160 gpm (640 L/min). Sun needle and flow control valves have nominal flow capacities up to 60 gpm (240 L/min) and are offered in both fully adjustable and fixed orifice versions. All Sun check and flow control valves are rated to 5000 psi (350 bar).

Check Cartridges

Sun check valves are offered in two configurations: nose-to-side free flow, port 1 to port 2, and side-to-nose free flow, port 2 to port 1. However, the nose-to-side free flow configuration is the preferred version for most applications. The side-to-nose version, which has a higher pressure drop, is non-preferred and is available to facilitate circuit requirements in complex manifold designs.

Needle and Fixed Orifice Cartridges

Sun's fully adjustable needle valves, with and without reverse free flow checks, are components that regulate flow. When placed ahead of an actuator or control device, these valves act as meter-in devices; when placed on the downstream side, they act as meter-out devices. The versions with reverse free flow checks are usually positioned between the control device and the actuator in order to select either the meter-in or meter-out function. (See Figure 1.)

Pressure Compensated Fully Adjustable and Fixed Orifice Flow Control Cartridges

Sun pressure compensated flow control valves are available with and without reverse flow checks. They are designed to provide precise flow regulation in applications where wide pressure variations exist. In addition to meter-in and meter-out circuits, these valves can be used in bleed-off circuits where the inlet flow and load pressure are relatively constant. (See Figure 2) Factory set flow ratings of the fixed orifice versions are within +/- 10% of the customer requested flow setting. The fixed orifice designs also offer an optional +/- 25% tuning adjustment of the factory setting.

Priority Flow Control Cartridges

Sun three port bypass and restrictive flow controls use a fixed orifice, plus a pressure compensator, to accurately control flow out priority port 3, while bypassing unused oil to port 2. Priority flow will remain relatively constant with varying input flows, and both the priority and bypass flows are usable up to system operating pressure. Although the excess flow at port 2 is available for secondary functions, the restrictive nature of this design, will cause all flow out of port 2 to be blocked if port 3 priority flow is blocked. *(It is recommended that a pressure relief valve be installed down stream of port 3 in order to insure that there is always a flow path available.)* (See Figure 3) In all cases, bypass flow will not occur until priority flow is satisfied. Also, an allowance for a minimum compensating pressure differential of 175-250 psi (12,2-17,5 bar) needs to be considered.

With the four port version, venting port 4 will cause this valve to divert all flow to port 2. (See Figures 4 and 5.) However, a minimum 150 psi (10,5 bar) inlet pressure at port 1 needs to be maintained for this function to occur.

Application Example

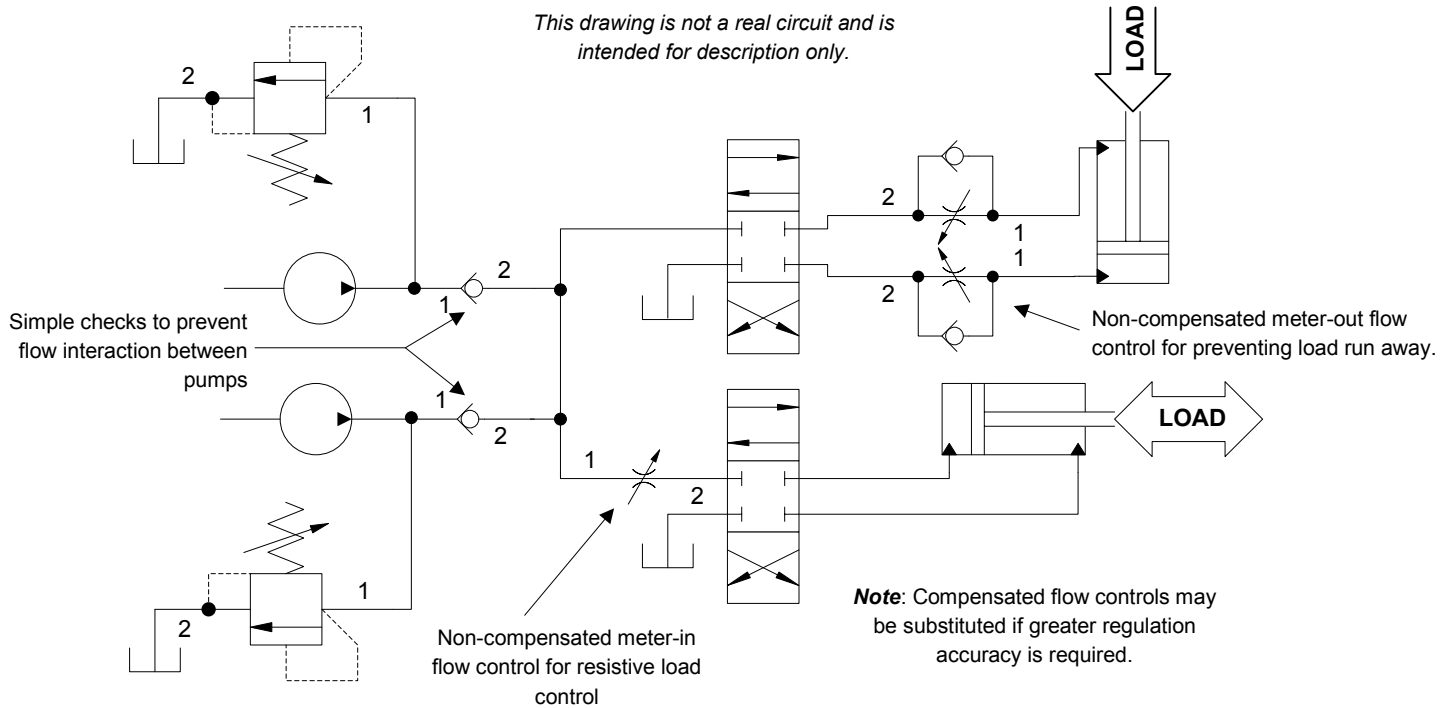

Figure 1. Meter-in, Meter-out Flow Control using 2 port check and flow control valves

Application Examples

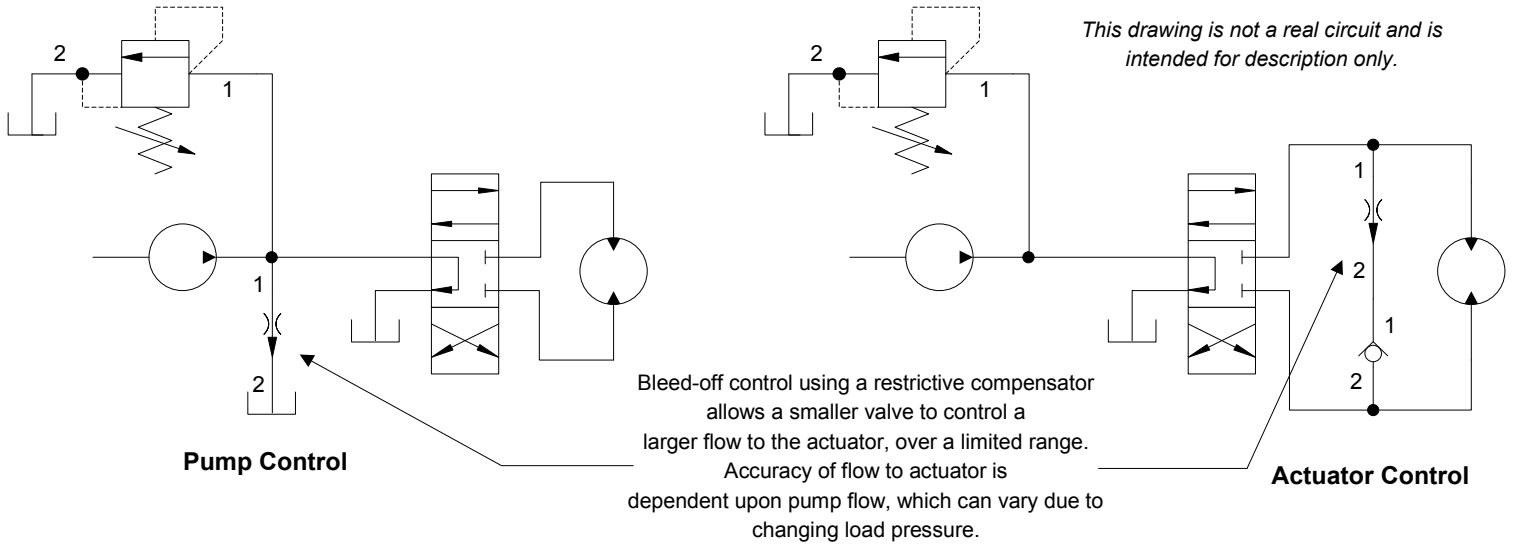

Figure 2. Bleed-Off Control for pump output flow and actuator speed

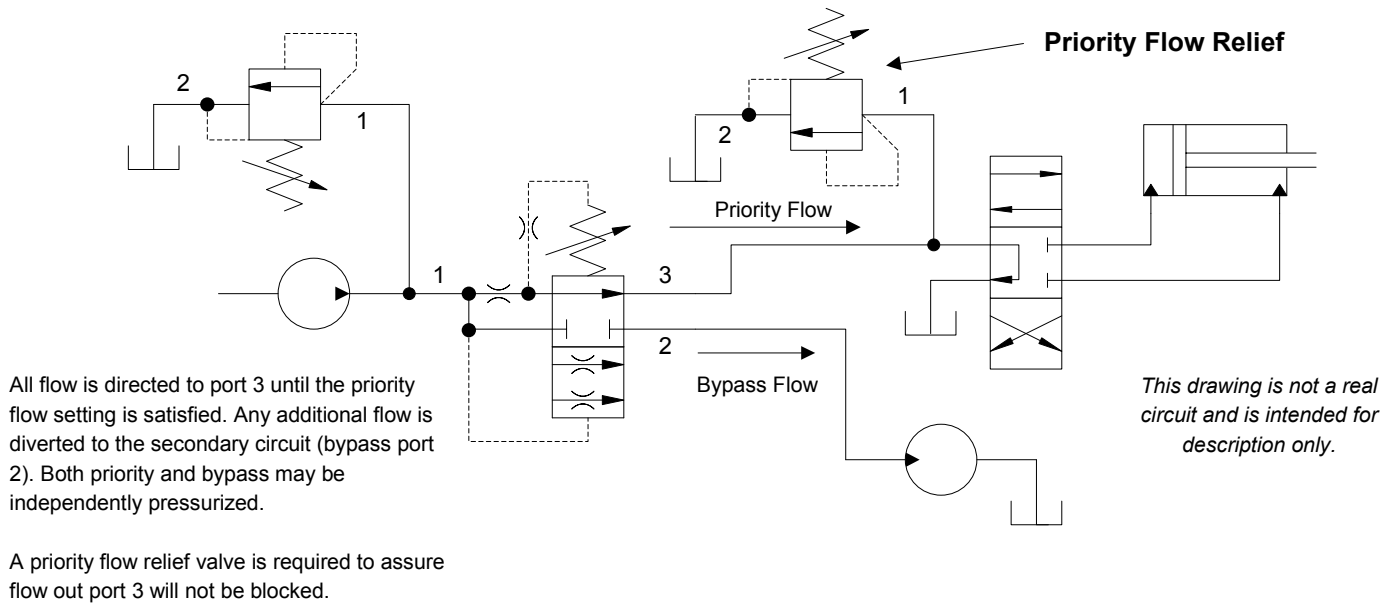
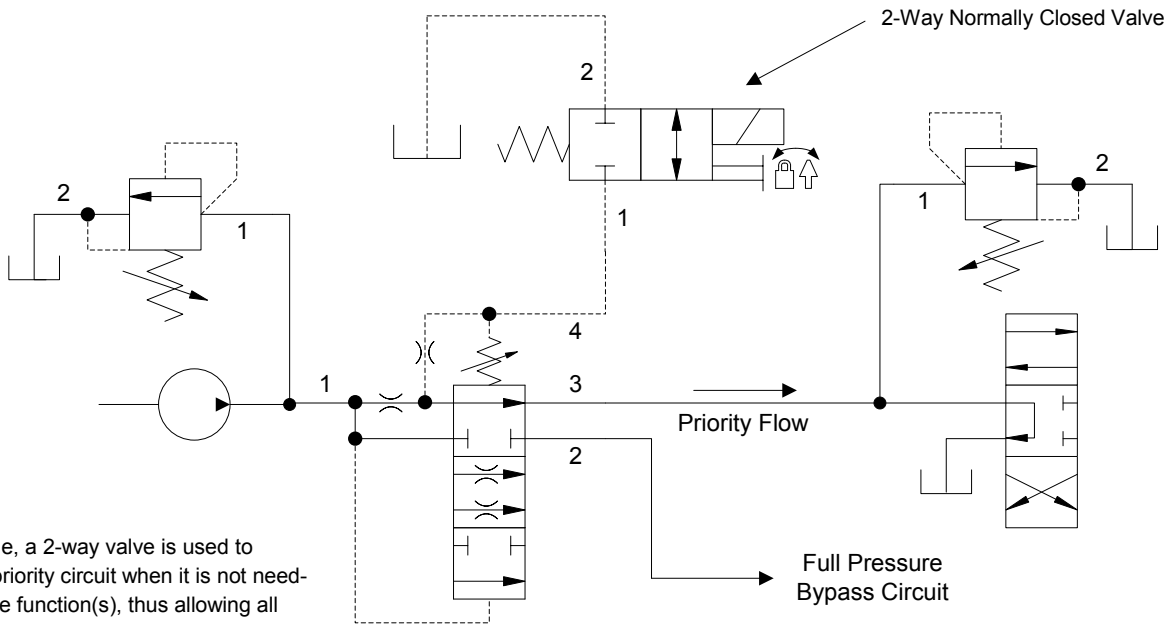

Figure 3. Bypass and restrictive priority control using 3 port flow control valves

Application Examples



In this example, a 2-way valve is used to deselect the priority circuit when it is not needed for machine function(s), thus allowing all pump flow to be available for the bypass or secondary circuit.

This drawing is not a real circuit and is intended for description only.

Figure 4. Deselecting a priority circuit using a 4 port ventable priority flow control.

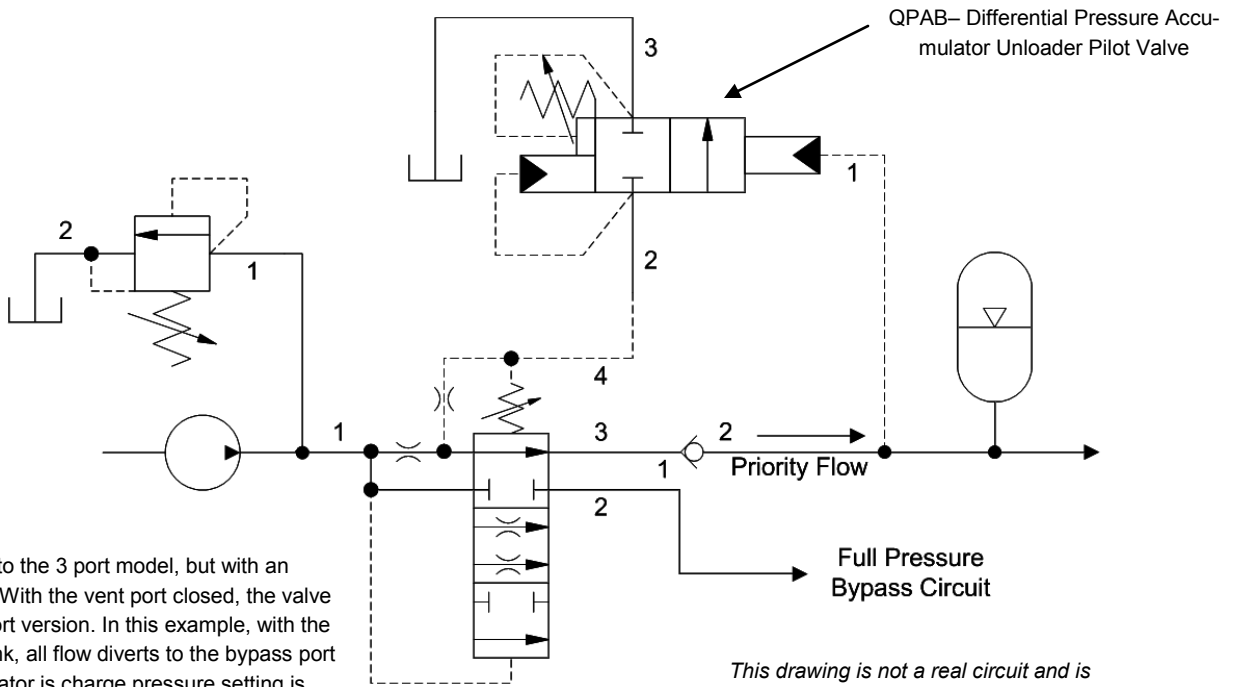

Similar in operation to the 3 port model, but with an additional vent port. With the vent port closed, the valve operates as the 3 port version. In this example, with the vent port open to tank, all flow diverts to the bypass port 2 when the accumulator is charge pressure setting is satisfied.

This drawing is not a real circuit and is intended for description only.

Figure 5. Unloading an accumulator with a 4 port ventable priority flow control.

Design Concepts and Features

Two Port Check Valve Cartridges – **CX*A**

Sun CX*A nose-to-side free flow (preferred) check valves offer six nominal flow capacities from 1.25 to 160 gpm (4,7 to 640 L/min), with free flow from port 1 to port 2, while blocking flow from port 2 to port 1. Performance parameters include:

- Low pressure drop relative to physical size.
- Low leakage from port 2 to port 1 when closed (less than 1 drop/min.)
- Eight cracking pressure spring ranges (1 to 150 psi [0,07 to 10,5 bar]).

Two Port Check Valve Cartridges – **CX*D**

Sun CX*D side-to-nose free flow (non-preferred) check valves offer five nominal flow capacities from 7.5 to 120 gpm (30 to 480 L/min), with free flow from port 2 to port 1, while blocking flow from port 1 to 2. Performance parameters include:

- Reverse flow path that can help to simplify complex manifold designs.
- Flow capacity is reduced, compared to CX*A cartridges.

Two Port Check Valve Cartridges with Bypass Orifices – **CNBC, CNDC, CNFC, CNHC, and CNJC**

Sun CN*C nose-to-side free flow check valves include a fixed bypass orifice that allows restricted flow from port 2 to port 1. Performance parameters include:

- Seven cracking pressure spring ranges (1 to 100 psi [0,07 to 7 bar]).
- Customer specified bypass orifice diameters from .016 to .354 in (0,4 – 9 mm), depending on frame size.

Three Port Check Valve Cartridges – **CX*C and CX*E**

Sun CX*C nose-to-side free flow and CX*E side-to-nose free flow “cheater” check valves have similar performance characteristics to CX*A and CX*D cartridges, respectively. However, they fit in three port cavities, but port 3 is blocked. Performance parameters include:

- Can be useful in a circuit where a check valve is required in an existing three port cavity. (An example would be to replace the counterbalance cartridge in a pressure sensitive regeneration assembly, thus converting it to full-time regeneration.)
- CX*E side-to-nose free flow versions offer a manual override option.

Two Port Needle Cartridges – **NF*C and NC*B**

Sun adjustable needle valves offer excellent metering characteristics for accurate and precise control of flow. (The NC*B versions also offer a high capacity reverse flow check.) Performance parameters include:

- A balanced adjusting mechanism for low operating effort with high load pressures.
- A sharp-edged orifice design that minimizes flow variation due to changes in viscosity. (Most viscosity variations are due to changes in fluid temperature.)

- Optional needle orifice ranges available in most frame sizes. (.16 to .56 in [4 to 14,2 mm])
- Positive shutoff of flow when closed. (Maximum leakage of 5 drops/min.)
- Five turns of adjustment

Two Port, Fixed Orifice, Non-Compensated Flow Control Cartridges – **CNAC, CNCC, CNEC, CNGC, and CNIC**

Sun CN*C side-to-nose free flow check valves include a fixed bypass orifice that allows restricted flow from port 1 to port 2. These valves can be considered non-adjustable, non-compensated, restrictive flow controls with reverse flow capability. Performance parameters include:

- Seven cracking pressure spring ranges (1 to 100 psi [0,07 to 7 bar]).
- Customer specified bypass orifice diameters from .016 to .250 in (0,4 to 6,4 mm), depending on frame size.
- Flow path matches Sun flow controls. (Can be used in any flow control manifold.)

Two Port Fixed Orifice Pressure Compensated Flow Control Cartridges – **FX*A and FC*B**

Sun fixed orifice, pressure compensated, flow controls offer accurate control of flow using a replaceable fixed orifice configuration. (The FC*B versions also offer a high capacity reverse flow check.) Performance parameters include:

- Minimum flow change with widely varying loads. (For flow settings in the bottom 2/3 of a given valve’s adjustment range, flow variations of less than +/- 5%, with a 4500 psi (310 bar) load change, are possible.)
- Stable operation over widely varying temperature ranges.
- Selectable fixed orifice sizes, from 0.1 to 50 gpm (0,4 to 200 L/min), depending on frame size. (Five frame sizes available.)
- A minimum of 200 psi (14 bar) pressure differential should be maintained for optimum pressure compensation.
- Factory settings are within +/- 10% of the customer requested flow setting.
- Tunable control option that provides a +/- 25% adjustment variation of the nominal factory set flow.

Two Port Fully Adjustable Pressure Compensated Flow Control Cartridges – **FD*A**

Sun fully adjustable pressure compensated FD*A flow controls include a free reverse flow check and offer the following features:

- Minimum flow change with widely varying loads. (For flow settings in the bottom 2/3 of a given valve’s adjustment range, flow variations of less than +/- 5%, with a 4500 psi (310 bar) load change, are possible.)
- Sharp-edged orifice design minimizes flow variation due to changes in viscosity.
- Five turns of adjustment with low operating effort at high load pressures.
- A minimum of 200 psi (14 bar) pressure differential should be maintained for optimum pressure compensation.
- Optional needle adjustment ranges available for system flow optimization.
- These valves will not provide zero flow. (Depending on frame size, minimum flows will be 0.1 to 0.2 gpm (0,4 to 0,8 L/min) at shutoff.)

Three Port Fixed Orifice Priority Flow Control Cartridges – FR*A

Sun three port FR*A pressure compensated flow controls combine bypass and restrictive functions in a single cartridge. These cartridges contain a replaceable, fixed orifice to control the priority flow out of port 3. Performance parameters include:

- Selectable priority flow orifice sizes, from 0.1 to 50 gpm (0,4 to 200 L/min), depending on frame size. (Five frame sizes available.)
- Both priority and bypass flows are usable up to the system operating pressure.
- As inlet flows increase, priority flow accuracy decreases when priority pressure rises higher than bypass pressure. *(With bypass pressure higher than priority pressure, the priority flow accuracy is very good. See individual valve performance curves shown on the appropriate product page.)*
- Stable operation over widely varying temperature ranges.
- Bypass flow will not be available until the priority flow requirement is satisfied.



- If priority flow becomes blocked, all flow, including bypass flow, will cease. *(Because of this characteristic, it recommended that a relief valve be installed in the priority circuit.)*
- Factory settings are within +/- 15% of the customer requested priority flow setting.
- Tunable control option that provides a +/- 25% adjustment variation of the nominal factory set flow.

Four Port, Ventable, Fixed Orifice Priority Flow Control Cartridges – FV*A

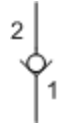
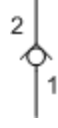
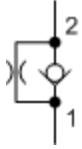
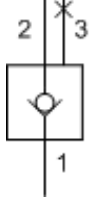
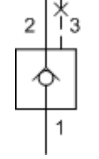

Sun ventable four port FV*A priority cartridges offer the same capabilities as the FR*A three port versions, but include an additional vent (port 4) connection for remote control. Other performance parameters include:

- With port 4 blocked, this valve functions just like an FR*A valve.
- Connecting port 4 to tank allows all input flow to be diverted to bypass port 2. *(Pressure at port 1 must be at least 150 psi [10,5 bar] for this function to occur.)*

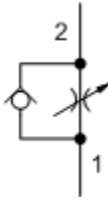
Check, Flow Control and Priority Flow Control Valves Overview

Function	Description	Nominal Capacity	Model	Cavity	Symbol
2 Port	Free Flow Nose-to-side	1.25 gpm (4,7 L/min.) 10 gpm (40 L/min.) 20 gpm (80 L/min.) 40 gpm (160 L/min.) 80gpm (320 L/min.) 160 gpm (640 L/min.)	CXAA CXBA CXDA CXFA CXHA CXJA	T-8A T-162A T-13A T-5A T-16A T-18A	
2 Port	Free Flow Side-to-nose	7.5 gpm (30 L/min.) 15 gpm (60 L/min.) 30 gpm (120 L/min.) 60 gpm (240 L/min.) 120 gpm (480 L/min.)	CXAD CXCD CXED CXGD CXID	T-162A T-13A T-5A T-16A T-18A	
2 Port	Bypass Orifice, Free Flow Nose-to-side	7.5 gpm (30 L/min.) 15 gpm (60 L/min.) 30 gpm (120 L/min.) 60 gpm (240 L/min.) 120 gpm (480 L/min.)	CNBC CNDC CNFC CNHC CNJC	T-162A T-13A T-5A T-16A T-18A	
3 Port	Free Flow Nose-to-side, Port 3 Blocked	20 gpm (80 L/min.) 40 gpm (160 L/min.) 80 gpm (320 L/min.) 120 gpm (480 L/min.)	CXDC CXFC CXHC CXJC	T-11A T-2A T-17A T-19A	
3 Port	Free Flow Side-to-nose, Port 3 Blocked	15 gpm (40 L/min.) 30 gpm (120 L/min.) 60 gpm (240 L/min.) 120 gpm (480 L/min.)	CXCE CXEE CXGE CXIE	T-11A T-2A T-17A T-19A	
2 Port	Fully Adjustable Needle Valve	.16 in. (4 mm) .19 in. (4,8 mm) .33 in. (8,4 mm) .25 in. (6,4 mm) .5 in. (12,7 mm) .38 in. (9,7 mm) .69 in. (17,5 mm) .56 in. (14,2 mm) .85 in. (21,6 mm)	NFBC NFCC NFCD NFDC NFDD NFEC NFED NFEC NFED NFCC NFDD	T-162A T-13A T-13A T-5A T-5A T-16A T-16A T-18A T-18A	
2 Port	Fully Adjustable Needle Valve, With Reverse Flow Check	16 in. (4 mm) .19 in. (4,8 mm) .09 in. (2,3 mm) .25 in. (6,4 mm) .5 in. (12,7 mm) .13 in. (3,3 mm) .38 in. (9,7 mm) .28 in. (7,1mm) .56 in. (14,2 mm) .38 in. (9,7 mm)	NCBB NCCB NCCC NCCD NCEB NCEC NCFB NCFC NCEB NCCB NCCD	T-162A T-13A T-13A T-13A T-5A T-5A T-16A T-16A T-18A T-18A	

Check, Flow Control and Priority Flow Control Valves Overview

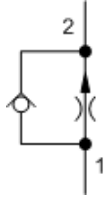
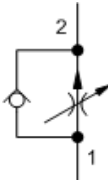
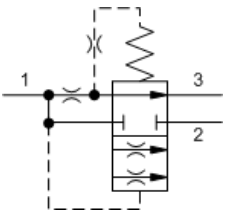
Function	Description	Nominal Capacity	Model	Cavity	Symbol
2 Port	Fixed Orifice, Non-compensated, with Reverse Flow Check	7.5 gpm (30 L/min.) 15 gpm (60 L/min.) 30 gpm (120 L/min.) 60 gpm (240 L/min.) 120 gpm (480 L/min.)	CNAC CNCC CNEC CNGC CNIC	T-162A T-13A T5A T-16A T-18A	
2 Port	Fixed Orifice, Pressure Compensated	3 gpm (11 L/min.) 6 gpm (23 L/min.) 12 gpm (45 L/min.) 25 gpm (95 L/min.) 50 gpm (200 L/min.)	FXBA FXCA FXDA FXEA FXFA	T-162A T-13A T-5A T-16A T-18A	
2 Port	Fixed Orifice, Pressure Compensated, with Reverse Flow Check	3 gpm (11 L/min.) 6 gpm (23 L/min.) 12 gpm (45 L/min.) 25 gpm (95 L/min.) 50 gpm (200 L/min.)	FCBB FCCB FCDB FCEB FCFB	T-162A T-13A T-5A T-16A T-18A	
2 Port	Fully Adjustable, Pressure Compensated, with Reverse Flow Check	6 gpm (23 L/min.) 12 gpm (45 L/min.) 25 gpm (95 L/min.) 50gpm (200 L/min.)	FDBA FDCB FDEA FDFA	T-13A T-5A T-16A T-18A	
3 Port	Fixed Orifice, Bypass/Restrictive	3 gpm (11 L/min.) 6 gpm (23 L/min.) 12 gpm (45 L/min.) 25 gpm (95 L/min.) 50 gpm (200 L/min.)	FRBA FRCA FRDA FREA FRFA	T-163A T-11A T-2A T-17A T-19A	
4 Port	Fixed Orifice, Bypass/Restrictive, Ventable	6 gpm (23 L/min.) 12 gpm (45 L/min.) 25 gpm (95 L/min.) 50 gpm (200 L/min.)	FVCA FVDA FVEA FVFA	T-21A T-22A T-23A T-24A	